

PRODUCT FEATURES

- Through bolt fixing, torque controlled expansion metal anchor.
- Long thread for various embedment depth.
- Wide range of lengths and diameters for installation flexibility.
- Anti-rotation lugs.

MATERIAL SPECIFICATIONS

- Bolt: Cold stamped carbon steel 5.8; zinc galvanised $\geq 5 \mu\text{m}$ & hot dipped galvanised $\geq 40 \mu\text{m}$.
- Nut: DIN 934; zinc galvanised $\geq 5 \mu\text{m}$ & hot dipped galvanised $\geq 40 \mu\text{m}$.
- Washer: DIN 125 or DIN 9021; zinc galvanised $\geq 5 \mu\text{m}$ & hot dipped galvanised $\geq 40 \mu\text{m}$.
- Clip: Cold stamped carbon steel 5.8; zinc galvanised $\geq 5 \mu\text{m}$ & hot dipped galvanised $\geq 40 \mu\text{m}$.



SUBSTRATES

- RC concrete C20/25 to C50/60 at maximum according to EN 206-1:2000-12.
- Solid stone & other solid masonry.



LOADING ZONES



BASIC LOADING DATA FOR TR & TR-GH

- For static and quasi-static loadings.
- For non-cracked concrete only.
- Only a single anchor is considered.
- No anchor spacing and edge distance influences.
- Concrete compressive strength C20/25 ($f_{ck,cube} = 25 \text{ N/mm}^2$).
- Loading applicable to both carbon steel zinc galvanised and hot dipped galvanised.

CHARACTERISTIC RESISTANCE [F_{Rk}]	Standard Anchorage Depth						Reduced Anchorage Depth						
	Anchor Size	M6	M8	M10	M12	M16	M20	M6	M8	M10	M12	M16	M20
Effective Depth, h_{ef} [mm]		40	45	50	70	85	100	30	35	40	50	60	75
Tensile Load, N_{Rk} [kN]		5.0	12.2	15.8	24.3	36.9	50.6	4.5	9.2	12.5	15.3	20.0	30.5
Shear Load, V_{Rk} [kN]		5.0	8.8	13.9	20.2	37.7	58.8	5.0	8.8	13.9	20.2	37.7	58.8

DESIGN RESISTANCE [F_{Rd}]	Standard Anchorage Depth						Reduced Anchorage Depth						
	Anchor Size	M6	M8	M10	M12	M16	M20	M6	M8	M10	M12	M16	M20
Effective Depth, h_{ef} [mm]		40	45	50	70	85	100	30	35	40	50	60	75
Tensile Load, N_{Rd} [kN]		3.3	8.1	10.5	16.2	24.6	33.7	3.0	6.1	8.3	10.2	13.3	20.3
Shear Load, V_{Rd} [kN]		4.0	7.0	11.1	16.2	30.1	47.0	4.0	7.0	11.1	16.2	30.1	47.0

RECOMMENDED LOAD [F_{Rec}]	Standard Anchorage Depth						Reduced Anchorage Depth						
	Anchor Size	M6	M8	M10	M12	M16	M20	M6	M8	M10	M12	M16	M20
Effective Depth, h_{ef} [mm]		40	45	50	70	85	100	30	35	40	50	60	75
Tensile Load, N_{Rec} [kN]		2.4	5.8	7.5	11.6	17.6	24.1	2.1	4.4	5.9	7.3	9.5	14.5
Shear Load, V_{Rec} [kN]		2.9	5.0	8.0	11.6	21.5	33.6	2.9	5.0	8.0	11.6	21.5	33.6

MECHANICAL PROPERTIES

ANCHOR SIZE		M6	M8	M10	M12	M16	M20
Cross Sectional Area, A_s [mm ²]		20.1	36.6	58.0	84.3	157.0	245.0
Nominal Tensile Strength At Thread, f_{uk} [N/mm ²]		520	500	500	500	500	500
Nominal Tensile Strength At Taper, $f_{uk,tp}$ [N/mm ²]		570	540	540	540	540	540
Elastic Moment Of Resistance, W_{el} [mm ³]		12.7	31.2	62.3	109.2	277.5	540.9
Design Bending Moment, $M_{Rd,s}$ [Nm]		6.3	15.0	29.9	52.4	133.2	259.6

The design bending moment is derived from $M_{Rd,s} = M_{Rk,s} / \gamma_{Mk,N}$ where the partial safety factor is 1.25. The recommended bending moment is derived from $M_{Rec,s} = M_{Rd,s} / \gamma_F$ where the partial safety factor is 1.4.

▶ SETTING DETAILS

ANCHOR SIZE		M6	M8	M10	M12	M16	M20
Drilled Hole Diameter, d_0	[mm]	6	8	10	12	16	20
Recommended Torque, T_{inst}	[Nm]	8	15	35	45	90	160
Fixture Hole Diameter, d_{fix}	[mm]	7	9	12	14	18	22
Wrench Size, W		10	13	17	19	24	30
Standard Anchorage Depth							
Minimum Hole Depth, h_1	[mm]	50	55	70	95	110	135
Embedment Depth, h_{nom}	[mm]	45	50	65	80	100	125
Standard Effective Anchorage Depth, $h_{ef, std}$	[mm]	40	45	50	70	85	100
Minimum Concrete Thickness, h_{min}	[mm]	75	85	100	120	150	190
Maximum Fixture Thickness, t_{fix}	[mm]	L - 50	L - 55	L - 70	L - 95	L - 110	L - 135
Critical Anchor Spacing, $s_{cr, N}$	[mm]	120	135	150	210	255	300
Minimum Anchor Spacing, s_{min}	[mm]	40	45	50	70	85	100
Critical Edge Distance, $c_{cr, N}$	[mm]	60	70	75	105	130	150
Minimum Edge Distance, c_{min}	[mm]	40	45	50	70	85	100
Reduced Anchorage Depth							
Minimum Hole Depth, h_1	[mm]	40	45	55	75	80	110
Embedment Depth, h_{nom}	[mm]	35	40	50	60	75	95
Reduced Effective Anchorage Depth, $h_{ef, red}$	[mm]	30	35	40	50	60	75
Minimum Concrete Thickness, h_{min}	[mm]	75	85	100	120	150	190
Maximum Fixture Thickness, t_{fix}	[mm]	L - 40	L - 45	L - 55	L - 75	L - 80	L - 110
Critical Anchor Spacing, $s_{cr, N}$	[mm]	90	105	120	150	180	225
Minimum Anchor Spacing, s_{min}	[mm]	30	35	40	50	60	75
Critical Edge Distance, $c_{cr, N}$	[mm]	45	55	60	75	90	115
Minimum Edge Distance, c_{min}	[mm]	30	35	40	50	60	75

▶ SETTING DIAGRAM

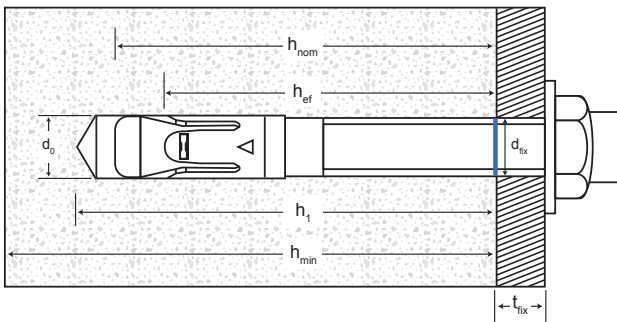

▶ INSTALLATION PROCEDURES

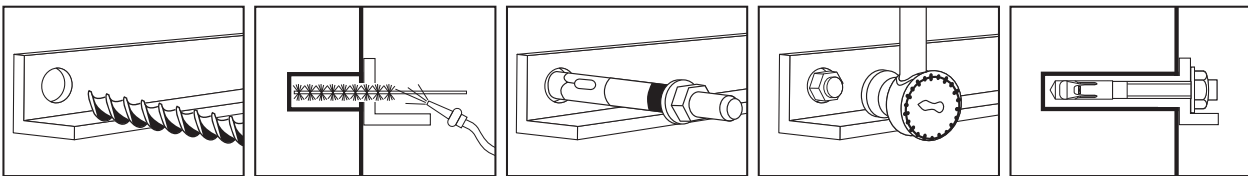

1. Examine the concrete base is well compact and porosity is insignificant. Drill a hole through the pre-drilled hole fixture into concrete at right angle to the substrate surface, to the specified diameter and depth.
2. Clean the drilled hole by using air pump or brush prior inserting the anchor.
3. Insert the anchor into the drilled hole by tapping lightly with a hammer until the fixing depth is reached. The installation could be done through the fixture hole.
4. Tighten the anchor according to the recommended torque.

TENSION LOAD [N_{Rd}]

Design Tensile Resistance, N_{Rd} :

lower value of [$N_{Rd,s}$; $N_{Rd,p}$; $N_{Rd,c}$]

Design Steel Tensile Resistance:

$N_{Rd,s}$

Design Pull-Out Resistance:

$N_{Rd,p} = N_{Rd,p}^0 \cdot \Psi_{h,N} \cdot \Psi_{\beta,N}$

Design Concrete Cone Resistance:

$N_{Rd,c} = N_{Rd,c}^0 \cdot \Psi_{h,N} \cdot \Psi_{\beta,N} \cdot \Psi_{s,N} \cdot \Psi_{c,N}$

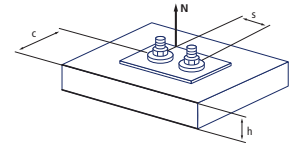

STEEL TENSILE RESISTANCE [$N_{Rd,s}$]

- For static and quasi-static loadings.
- Only a single anchor is considered.
- For non-cracked concrete only.
- Loading applicable to both carbon steel zinc galvanised and hot dipped galvanised.

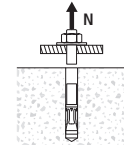

ANCHOR SIZE	Standard Anchorage Depth						Reduced Anchorage Depth					
	M6	M8	M10	M12	M16	M20	M6	M8	M10	M12	M16	M20
h_{ef} [mm]	40	45	50	70	85	100	30	35	40	50	60	75
$N_{Rd,s}$ [kN]	7.0	12.2	19.3	28.1	52.3	81.7	7.0	12.2	19.3	28.1	52.3	81.7

The design steel tensile resistance is derived from $N_{Rd,s} = N_{Rk,s} / \gamma_{M5,N}$ where the partial safety factor is 1.5. The recommended load is derived from $N_{Rec,s} = N_{Rd,s} / \gamma_F$ where the partial safety factor is 1.4.

PULL-OUT RESISTANCE [$N_{Rd,p}$]

- For static and quasi-static loadings.
- For non-cracked concrete only.
- Only a single anchor is considered.
- No anchor spacing and edge distance influences.
- Concrete compressive strength C20/25 ($f_{k,cube} = 25 \text{ N/mm}^2$).
- Loading applicable to both carbon steel zinc galvanised and hot dipped galvanised.

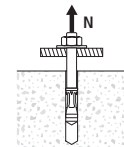

ANCHOR SIZE	Standard Anchorage Depth						Reduced Anchorage Depth					
	M6	M8	M10	M12	M16	M20	M6	M8	M10	M12	M16	M20
h_{ef} [mm]	40	45	50	70	85	100	30	35	40	50	60	75
$N_{Rd,p}^0$ [kN]	3.3	8.1	10.5	16.2	24.6	33.7	3.0	6.1	8.3	10.2	13.3	20.3

The design pull-out resistance is derived from $N_{Rd,p}^0 = N_{Rk,p}^0 / \gamma_{M6,N}$ where partial of safety factor varies for different sizes. The recommended load is derived from $N_{Rec,p}^0 = N_{Rd,p}^0 / \gamma_F$ where the partial safety factor is 1.4.

CONCRETE CONE RESISTANCE [$N_{Rd,c}$]

- For static and quasi-static loadings.
- For non-cracked concrete only.
- Only a single anchor is considered.
- No anchor spacing and edge distance influences.
- Concrete compressive strength C20/25 ($f_{k,cube} = 25 \text{ N/mm}^2$).
- Loading applicable to both carbon steel zinc galvanised and hot dipped galvanised.

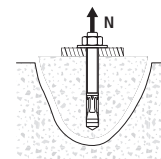

ANCHOR SIZE	Standard Anchorage Depth						Reduced Anchorage Depth					
	M6	M8	M10	M12	M16	M20	M6	M8	M10	M12	M16	M20
h_{ef} [mm]	40	45	50	70	85	100	30	35	40	50	60	75
$N_{Rd,c}^0$ [kN]	8.5	10.2	11.9	19.7	26.4	33.7	5.5	7.0	8.5	11.9	15.6	21.9

The design concrete cone resistance is derived from $N_{Rd,c}^0 = N_{Rk,p}^0 / \gamma_{M6,N}$ where the partial safety factor is 1.5. The recommended load is derived from $N_{Rec,c}^0 = N_{Rd,c}^0 / \gamma_F$ where the partial safety factor is 1.4.

SHEAR LOAD [V_{Rd}]

Design Shear Resistance, V_{Rd}:

lower value of [V_{Rd,s}; V_{Rd,c}; V_{Rd,cp}]

Design Steel Shear Resistance:

V_{Rd,s}

Design Concrete Edge Shear Resistance:

V_{Rd,c} = V⁰_{Rd,c} · Ψ_{β,V} · Ψ_{α,V} · Ψ_{sc,V}

Design Concrete Pry-Out Resistance:

V_{Rd,cp} = V⁰_{Rd,cp} · Ψ_{β,V} · Ψ_{s,N} · Ψ_{c,N}

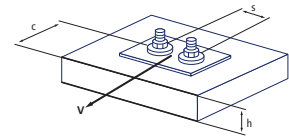

STEEL SHEAR RESISTANCE [V_{Rd,s}]

- For static and quasi-static loadings.
- Only a single anchor is considered.
- For non-cracked concrete only.
- Loading applicable to both carbon steel zinc galvanised and hot dipped galvanised.

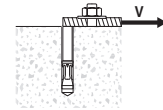

ANCHOR SIZE	Standard Anchorage Depth						Reduced Anchorage Depth					
	M6	M8	M10	M12	M16	M20	M6	M8	M10	M12	M16	M20
h _{ef} [mm]	40	45	50	70	85	100	30	35	40	50	60	75
V _{Rd,s} [kN]	4.0	7.0	11.1	16.2	30.1	47.0	4.0	7.0	11.1	16.2	30.1	47.0

The design steel shear resistance is derived from V_{Rd,s} = V_{Rk,s} / γ_{M_s,V} where the partial safety factor is 1.25. The recommended load is derived from V_{Rec,s} = V_{Rd,s} / γ_F where the partial safety factor is 1.4.

CONCRETE EDGE SHEAR RESISTANCE [V_{Rd,c}]

- For static and quasi-static loadings.
- For non-cracked concrete only.
- Only a single anchor is considered.
- No anchor spacing and edge distance influences.
- Concrete compressive strength C20/25 (f_{ck,cube} = 25 N/mm²).
- Loading applicable to both carbon steel zinc galvanised and hot dipped galvanised.

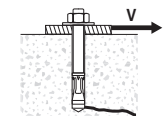

ANCHOR SIZE	Standard Anchorage Depth						Reduced Anchorage Depth					
	M6	M8	M10	M12	M16	M20	M6	M8	M10	M12	M16	M20
h _{ef} [mm]	40	45	50	70	85	100	30	35	40	50	60	75
c _{min} [mm]	40	45	50	70	85	100	30	35	40	50	60	75
V ⁰ _{Rd,c} [kN]	2.8	3.9	5.1	9.2	14.2	20.3	1.8	2.7	3.6	5.6	8.4	13.2

The design concrete edge shear resistance is derived from V_{Rd,c} = V⁰_{Rd,c} / γ_{M_c,V} where the partial safety factor is 1.5. The recommended load is derived from V⁰_{Rec,c} = V⁰_{Rd,c} / γ_F where the partial safety factor is 1.4.

CONCRETE PRY-OUT RESISTANCE [V_{Rd,cp}]

- For static and quasi-static loadings.
- For non-cracked concrete only.
- Only a single anchor is considered.
- No anchor spacing and edge distance influences.
- Concrete compressive strength C20/25 (f_{ck,cube} = 25 N/mm²).
- Loading applicable to both carbon steel zinc galvanised and hot dipped galvanised.

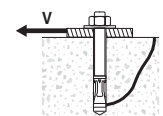

ANCHOR SIZE	Standard Anchorage Depth						Reduced Anchorage Depth					
	M6	M8	M10	M12	M16	M20	M6	M8	M10	M12	M16	M20
h _{ef} [mm]	40	45	50	70	85	100	30	35	40	50	60	75
V ⁰ _{Rd,cp} [kN]	8.5	10.2	11.9	39.4	52.8	67.3	5.5	7.0	8.5	11.9	31.3	43.7

The design concrete pry-out resistance is derived from V_{Rd,cp} = V⁰_{Rd,cp} / γ_{M_p,V} where the partial safety factor is 1.5. The recommended load is derived from V⁰_{Rec,cp} = V⁰_{Rd,cp} / γ_F where the partial safety factor is 1.4.

COMBINED TENSION & SHEAR

$$\text{Combined Tension \& Shear: } \frac{N_{Sd}}{N_{Rd}} + \frac{V_{Sd}}{V_{Rd}} \leq 1.2$$

The resultant force must be satisfied to the above conditions. The designer must cross check the loading conditions, types of applied loads and substrate to ensure the recommended anchor is applicable to the actual site applications. This would avoid any design faults which commonly caused by inconclusive load requirements with respective to actual site conditions.

► INFLUENCING FACTORS - TENSION

INFLUENCE OF ANCHORAGE DEPTH [$\Psi_{h,N}$]

$$\Psi_{h,N} = \left(\frac{h_{act}}{h_{ef}} \right)^{1.5} \quad \text{Limits: } h_{ef,red} \leq h_{act} \leq h_{ef,std}$$

INFLUENCE OF CONCRETE STRENGTH ON PULL-OUT AND CONCRETE CONE RESISTANCE [$\Psi_{\beta,N}$]

$$\Psi_{\beta,N} = \sqrt{\frac{f_{ck,cube}}{25}} \quad \text{Limits: } 25 \text{ MPa} \leq f_{ck,cube} \leq 60 \text{ MPa}$$

Concrete Strength Designation (ENV 206)	C 20/25	C 25/30	C 30/37	C 35/45	C 40/50	C 50/60
Concrete Cylinder Strength, $f_{ck,cyl}$ [MPa]	20	25	30	35	40	50
Concrete Cube Strength, $f_{ck,cube}$ [MPa]	25	30	37	45	50	60
Concrete Strength Factor, $\Psi_{\beta,N}$	1.00	1.10	1.22	1.34	1.41	1.55

INFLUENCE OF ANCHOR SPACING [$\Psi_{s,N}$]

Standard Anchorage Depth						
Anchor Spacing 's' [mm]	M6	M8	M10	M12	M16	M20
40	0.67					
45	0.69	0.67				
50	0.71	0.69	0.67			
70	0.79	0.76	0.73	0.67		
85	0.85	0.81	0.78	0.70	0.67	
100	0.92	0.87	0.83	0.74	0.70	0.67
120	1.00	0.94	0.90	0.79	0.74	0.70
135		1.00	0.95	0.82	0.76	0.73
150			1.00	0.86	0.79	0.75
210				1.00	0.91	0.85
255					1.00	0.93
300						1.00
Critical Spacing ' s_{cr} ' [mm]	120	135	150	210	255	300
Minimum Spacing ' s_{min} ' [mm]	40	45	50	70	85	100

Reduced Anchorage Depth						
Anchor Spacing 's' [mm]	M6	M8	M10	M12	M16	M20
30	0.67					
35	0.69	0.67				
40	0.72	0.69	0.67			
50	0.78	0.74	0.71	0.67		
60	0.83	0.79	0.75	0.70	0.67	
75	0.92	0.86	0.81	0.75	0.71	0.67
90	1.00	0.93	0.88	0.80	0.75	0.70
105		1.00	0.94	0.85	0.79	0.73
120			1.00	0.90	0.83	0.77
150				1.00	0.92	0.83
180					1.00	0.90
225						1.00
Critical Spacing ' s_{cr} ' [mm]	90	105	120	150	180	225
Minimum Spacing ' s_{min} ' [mm]	30	35	40	50	60	75

$$\Psi_{s,N} = 0.5 + \frac{s}{6 * h_{ef}} \quad \text{Limits: } s_{min} \leq s \leq s_{cr}$$

$$s_{min} = 1.0 * h_{ef}$$

$$s_{cr} = 3.0 * h_{ef}$$

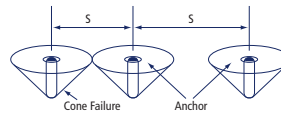

INFLUENCE OF EDGE DISTANCE [$\Psi_{c,N}$]

Standard Anchorage Depth						
Edge Distance 'c' [mm]	M6	M8	M10	M12	M16	M20
40	0.76					
45	0.82	0.76				
50	0.88	0.81	0.76			
60	1.00	0.92	0.85			
70		1.00	0.95	0.76		
75			1.00	0.79		
85				0.86	0.76	
100				0.96	0.84	0.76
105				1.00	0.87	0.78
130					1.00	0.90
150						1.00
Critical Edge Distance ' c_{cr} ' [mm]	60	70	75	105	130	150
Minimum Edge Distance ' c_{min} ' [mm]	40	45	50	70	85	100

Reduced Anchorage Depth						
Edge Distance 'c' [mm]	M6	M8	M10	M12	M16	M20
30	0.76					
35	0.84	0.76				
40	0.92	0.83	0.76			
45	1.00	0.89	0.82			
50		0.96	0.88	0.76		
55		1.00	0.94	0.81		
60			1.00	0.85	0.76	
75				1.00	0.88	0.76
90					1.00	0.85
115						1.00
Critical Edge Distance ' c_{cr} ' [mm]	45	55	60	75	90	115
Minimum Edge Distance ' c_{min} ' [mm]	30	35	40	50	60	75

$$\Psi_{c,N} = 0.29 + 0.47 * \frac{c}{h_{ef}} \quad \text{Limits: } c_{min} \leq c \leq c_{cr}$$

$$c_{min} = 1.0 * h_{ef}$$

$$c_{cr} = 1.5 * h_{ef}$$

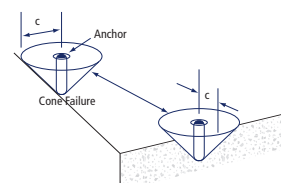

► INFLUENCING FACTORS - SHEAR

INFLUENCE OF CONCRETE STRENGTH ON CONCRETE EDGE SHEAR AND CONCRETE PRY-OUT RESISTANCE [$\Psi_{\beta,V}$]

$$\Psi_{\beta,V} = \sqrt{\frac{f_{ck,cube}}{25}} \quad \text{Limits: } 25 \text{ MPa} \leq f_{ck,cube} \leq 60 \text{ MPa}$$

Concrete Strength Designation (ENV 206)	C 20/25	C 25/30	C 30/37	C 35/45	C 40/50	C 50/60
Concrete Cylinder Strength, $f_{ck,cyl}$ [MPa]	20	25	30	35	40	50
Concrete Cube Strength, $f_{ck,cube}$ [MPa]	25	30	37	45	50	60
Concrete Strength Factor, $\Psi_{\beta,V}$	1.00	1.10	1.22	1.34	1.41	1.55

INFLUENCE OF SHEAR LOAD DIRECTION [$\Psi_{\alpha,V}$]

Load Type	Angle, α [°]	$\Psi_{\alpha,V}$
Oblique 0°	$0^\circ < \alpha \leq 15^\circ$	1.00
Oblique 30°	$15^\circ < \alpha \leq 37.5^\circ$	1.14
Oblique 45°	$37.5^\circ < \alpha \leq 52.5^\circ$	1.35
Oblique 60°	$52.5^\circ < \alpha \leq 67.5^\circ$	1.71
Oblique 90°	$67.5^\circ < \alpha \leq 90^\circ$	2.00

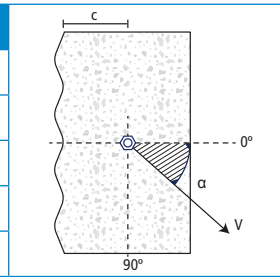

INFLUENCE OF ANCHOR SPACING AND EDGE DISTANCE ON CONCRETE EDGE SHEAR RESISTANCE [$\Psi_{sc,V}$]

$$\Psi_{sc,V} = \frac{c}{c_{min}} * \sqrt{\frac{c}{c_{min}}} \quad \text{for single anchor towards a concrete edge}$$

$$\Psi_{sc,V} = \frac{3c + s}{6c_{min}} * \sqrt{\frac{c}{c_{min}}} \quad \text{for two anchors when } s \leq 3c$$

$$\Psi_{sc,V} = \frac{3c + s_1 + s_2 + s_{n-1}}{3nc_{min}} * \sqrt{\frac{c}{c_{min}}} \quad \text{for multiple anchors when } s_1 \text{ to } s_{n-1} \leq 3c \text{ and } c_2 \geq 1.5c$$

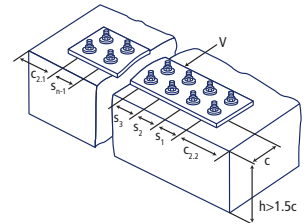

$\Psi_{sc,V}$	Edge influence with single anchor	c / c_{min}															
		1.0	1.2	1.4	1.6	1.8	2.0	2.2	2.4	2.6	2.8	3.0	3.2	3.4	3.6	3.8	4.0
s / c_{min}	1.0	0.67	0.84	1.03	1.22	1.43	1.65	1.88	2.12	2.36	2.62	2.89	3.16	3.44	3.73	4.03	4.33
	1.5	0.75	0.93	1.12	1.33	1.54	1.77	2.00	2.25	2.50	2.76	3.03	3.31	3.60	3.89	4.19	4.50
	2.0	0.83	1.02	1.22	1.43	1.65	1.89	2.13	2.38	2.63	2.90	3.18	3.46	3.75	4.05	4.35	4.67
	2.5	0.92	1.11	1.32	1.54	1.77	2.00	2.25	2.50	2.77	3.04	3.32	3.61	3.90	4.21	4.52	4.83
	3.0	1.00	1.20	1.42	1.64	1.88	2.12	2.37	2.63	2.90	3.18	3.46	3.76	4.06	4.36	4.68	5.00
	3.5		1.30	1.52	1.75	1.99	2.24	2.50	2.76	3.04	3.32	3.61	3.91	4.21	4.52	4.84	5.17
	4.0			1.62	1.86	2.10	2.36	2.62	2.89	3.17	3.46	3.75	4.05	4.36	4.68	5.00	5.33
	4.5				1.96	2.21	2.47	2.74	3.02	3.31	3.60	3.90	4.20	4.52	4.84	5.17	5.50
	5.0					2.33	2.59	2.87	3.15	3.44	3.74	4.04	4.35	4.67	5.00	5.33	5.67
	5.5						2.71	2.99	3.28	3.57	3.88	4.19	4.50	4.82	5.15	5.49	5.83
	6.0						2.83	3.11	3.41	3.71	4.02	4.33	4.65	4.98	5.31	5.65	6.00
	6.5							3.24	3.53	3.84	4.16	4.47	4.80	5.13	5.47	5.82	6.17
	7.0								3.67	3.98	4.29	4.62	4.95	5.29	5.63	5.98	6.33
	7.5									4.11	4.43	4.76	5.10	5.44	5.79	6.14	6.50
	8.0										4.57	4.91	5.25	5.59	5.95	6.30	6.67
	8.5											5.05	5.40	5.75	6.10	6.47	6.83
	9.0											5.20	5.55	5.90	6.26	6.63	7.00
	9.5												5.69	6.05	6.42	6.79	7.17
	10.0													6.21	6.58	6.95	7.33
	10.5														6.74	7.12	7.50
11.0															7.28	7.67	
11.5																7.83	
12.0																	8.00